



IECEX Operational Document

**IEC System for Certification to Standards relating to
Equipment for use in Explosive Atmospheres**

OD 011-2

**Guidance on Use of the IECEx Internet based “On-Line”
Certificate of Conformity System – Second Generation**

**Part 2: Creating IECEx Equipment Certificates of Conformity
CoCs and supporting Reports (ExTR Summary and QAR
Summary)**

Readline Version

CONTENTS

1	IECEX Equipment Certificates of Conformity (CoCs)	5
1.1	General Information	5
1.1.1	System	5
1.1.2	Passwords Secure Access	5
1.1.3	Further Guidance	5
1.1.4	Printing CoCs as documents and PDF files	5
1.2	Notes for each field of the Certificate	6
1.2.1	Certificate No:	6
1.2.2	Ex Component Certificates	6
1.2.3	History	6
1.2.4	Status	6
1.2.5	Date of Issue	7
1.2.6	Issue No.	7
1.2.7	Applicant	8
1.2.8	Equipment (name)	8
1.2.9	Type of Protection	8
1.2.10	Marking	8
1.2.11	Approved for issue on behalf of the IECEX Certification Body	9
1.2.12	Position	9
1.2.13	Signature (printed version only)	9
1.2.14	Date (printed version only)	9
1.2.15	Manufacturer	9
1.2.16	Manufacturing locations (Where more than one)	10
1.2.17	Standards	10
1.2.18	IECEX Test & Assessment Report Summaries (Test Report Summary (ExTR) and Quality Assessment Report Summary (QAR))	10
1.2.19	Equipment (Field)	11
1.2.20	Specific Conditions of Use	11
1.2.21	Annex and Attachments	11
2	Creation of a new IECEX Equipment Certificate of Conformity	13
2.1	Entering new CoC details	13
2.2	Entering ExTR and QAR details	15

2.3	Formatting Features	16
2.4	Creating a “New Issue” of an existing CoC	17
3	Entering Registration of an IECEX ExTR Summary	18
3.1	Registration of a new IECEX ExTR Summary	18
3.2	Notes for the various fields of an ExTR Summary:	19
4	Registration of an IECEX QAR Summary	21
4.1	Registration of a new IECEX QAR Summary	21
4.2	Notes for the various Fields of an IECEX QAR Summary (“QAR”):	22
4.3	Supplementary or changes/updates to an Issued QAR Summary	27 26
4.3.1	Application:	27 26
4.4	Management of the validity of QAR Summaries and linked Certificates	28 27
5	Creation of an UNIT VERIFICATION type of IECEX Equipment Certificate of Conformity	29 28
5.1	Entering new Unit Verification CoC details	29 28
ANNEX A Typical Scenarios and Process Outcomes in Managing QARs	28

Readline Version

INTERNATIONAL ELECTROTECHNICAL COMMISSION

IECEX Operational Document OD 011-2

**Guidance on Use of the IECEX “On-Line” Certificate of Conformity System
Part 2: Creating IECEX Equipment Certificates of Conformity CoCs**

INTRODUCTION

This Operational Document provides guidance for IECEX Certification Bodies (ExCBs) when creating IECEX Equipment Certificates of Conformity (CoCs) using the IECEX Internet based “On-Line” Equipment Certificate of Conformity System.

OD 011 consists of five parts as follows:

<i>OD011, Guidance on Use of the IECEX Internet based “On-Line” Certificate of Conformity System</i>	
<i>OD 011-1</i>	<i>Part 1: General Information</i>
<i>OD 011-2</i>	<i>Part 2: Creating IECEX Equipment Certificates of Conformity CoCs (This part)</i>
<i>OD 011-3</i>	<i>Part 3: Creating IECEX Service Facility Certificates of Conformity CoCs</i>
<i>OD 011-4</i>	<i>Part 4: Creating IECEX Conformity Mark Licenses</i>
<i>OD 011-5</i>	<i>Part 5: Creating Certificates of Personnel Competence</i>
<i>OD 011-10</i>	<i>Part 10: IECEX OCS Back Office</i>

This Document should be read in conjunction with OD 011-1, *Part 1: General Information*. As a means of promoting the IECEX and its Members, OD 011-1 has been prepared in a format suitable for public access.

Document History

Date	Summary
2003 08	Original Issue (Edition 1)
2009 05	Edition 4.2 This edition of IECEX OD 011-2 has been issued to take into account a number of editorial formatting changes. Clause 1.2.2 has been updated. The Annexes in the previous edition have been redesignated as Sections.
2010-08	Edition 4.3 This edition of IECEX OD 011-2 has been issued to edit how “Related Certificates” are recorded in all issues of a QAR, provide printing guidance and make reference to Part 5.
2015-02	Edition 4.4 This edition of IECEX OD 011-2 has been issued to (1) take into account a number of editorial layout changes to a QAR and (2) incorporate the content of the Special Addendum to IECEX OD 011-2 Edition 1 as Section 5. Also a number of Clauses have been updated. Changes are shown with a “Red” margin.
2019 01	Edition 4.5 This edition created to reflect changes of layout and imagery of on-line Certificate System
2019-09	Edition 5.0 is a complete revision to cover the use of the second generation of IECEX On-line Certificate System (IECEX OCS)
2019-10	Edition 5.1 published to include additional guidance on use of the new IECEX OCS
2019-11	Edition 5.2 published to provide guidance on the calculation and selection of dates for the fields of QAR Summaries and on the use of the new OCS for editing these. The changes are indicated by red margin bars.
2019-12	Edition 5.3 published to provide clearer guidance on the creation of Ex Component Certificates in Sections 1.2.2 and 2 of this Operational Document
2021 -05	Edition 5.4 published to provide increased guidance on the preparation and issue of Unit Verification Certificates – refer to Section 5.1
2012-11	Edition 5.5 published to explain new feature for QAR Summary format regarding cessation of management of a QAR series – refer to Section 4.2
2022-02	Edition 5.6 published to align with IECEX 02, Edition 8.0
2022-02	Edition 5.7 published to align with IECEX 02, Edition 8.0 regarding Certificate format for manufacturing locations and to provide additional guidance on use of the ‘stopwatch’ icon for QAR Summary maintenance
2022-06	Edition 5.8 published to align with IECEX 02, Edition 8.0 regarding Certificate format for manufacturing locations and to provide options for manual inclusion of Manufacturer details in Manufacturing Locations field.
2023-05	Edition 5.9 published to include revisions agreed by the April 2023 meeting of ExMC WG5

Address:

**IECEX Secretariat
Level 33, Australia Square
264 George Street
Sydney NSW 2000
Australia**

**Tel: +61 2 4628 4690
Fax: +61 2 4627 5285
Email: info@iecex.com**

Guidance on Use of the IECEx “On-Line” Certificate of Conformity System Part 2: Creating IECEx Equipment Certificates of Conformity CoCs

1 IECEx Equipment Certificates of Conformity (CoCs)

1.1 General Information

1.1.1 System

The IECEx CoC System is based on the IECEx On-line Certificate System (“IECEx OCS”) that uses HTML as per most Web based documents. The items below provide guidance to ExCBs when creating CoCs.

1.1.2 Passwords Secure Access

The IECEx OCS uses a two level password system (as outlined in [IECEx OD 011-1](#) and below) to provide the necessary security for the content of IECEx Certificates and supporting Reports.

- a) A 1st level password (that provides *ExCBBasic* access rights) that the ExCB’s Official IECEx representative may provide to various staff within their organisation, to enable them to create a new certificate as a Draft. This level password will enable the staff member to create a new draft certificate and save it as a draft. It WILL NOT allow them to change the status from “Draft” to “Current”.
- b) A 2nd level password (that provides *ExCBAdmin* access rights) that is assigned to the official IECEx representative for issue only for the function that is authorised (within the ExCB management system) to formally issue certificates. This 2nd level password enables the person the same access as the 1st level password PLUS the authority to change the Status from “Draft” to “Current”.

The two levels of passwords mean that entering certificate information can be done by staff within the ExCB other than the certification authority. The 2nd level password ensures that there is the final check by the authorised person.

It is most important that the ExCB’s official representative to IECEx ensures that these passwords are kept secure and that they notify the IECEx Secretary immediately, of any possible breaches of security as new passwords can be assigned.

1.1.3 Further Guidance

For further information or guidance on using this new IECEx OCS please contact the IECEx Secretariat.

1.1.4 Printing CoCs as documents and PDF files

The second generation IECEx OCS displays and stores IECEx Certificates and Reports as PDF files – the following guidance is provided to assist with printing CoCs from the IECEx OCS as hard copy documents.

The preferred browser is Google Chrome or Internet Explorer 10 or later. Compatibility with other browsers like Microsoft Edge and Safari is maintained wherever possible however it is recommended that these not be relied upon and should functional issues occur, please use Internet Explorer or Chrome.

The facility to “download” CoCs to electronic files in PDF format is available (uncontrolled version) however it should be understood that these are uncontrolled copies and may not represent the latest version that is maintained on the IECEx OCS as the Master version.

To accommodate the need for ExCBs to provide uncontrolled copies of certificates with electronic signatures and other non-technical content additions the facility for ExCBs to

download CoCs as unsecured PDF files exists – this requires the ExCB to login using their

password (refer Section 1.1.2 above) and then download the PDF using the  icon – this will create an unsecured PDF file that can be edited using Adobe Acrobat or similar software to insert text, images, etcetra.

1.2 Notes for each field of the Certificate

1.2.1 Certificate No:

The certificate number consists of the following characters:

IECEX YYY ZZ.0000

The “0000” field is automatically generated by the System and advances in number by “1” for new versions.

Note that a facility exists to add a suffix to the certificate number to denote that additional information (such as conditions or exclusions to the certificate) exists within or attached to the certificate.

Concerning the use of the “X” suffix to cover conditions, this suffix is automatically added to the certificate number when the ExCB selects “YES” to the field “Specific Conditions of Use” when creating a normal Equipment certificate (ie, NOT an Ex Component type certificate).

The use of the “U” suffix indicates that the certificate relates to the certification of a component. Ex Component certificates may be issued for items of equipment that will not and cannot be used independently or separately from other equipment or components – *note the following subclause that outlines special considerations for the preparation of Ex Component type certificates.*

1.2.2 Ex Component Certificates

IEC 60079-0 defines (refer Clause 3.12.1) Ex Component Certificates as a different type of certificate that is not a ‘sub type’ of Ex Equipment Certificates (refer Clause 3.12.2 of IEC 60079-0). In the IECEx System, Ex Component Certificates have a different format, hence when an ExCB is preparing a Ex Component Certificate the Component Certificate option needs to be selected under the Report / Certificate type section after selection of the **Create** icon (refer Section 2 in this OD for further guidance) . This will then select the Component Certificate template which contains the necessary features that are required for a Component Certificate, including the “Label Header” and “Schedule of Limitations” fields. The option also exists to select “Unit Verification” by clicking the Unit Verification button for a Component Certificate. When up-issuing an old current version Component Certificate (pre-June 2018) the new template will be automatically used when the Component Certificate button is selected.

1.2.3 History

All new CoCs will contain a “History” block. The History block will show all the Issues of a particular CoC that have been created and the respective date. Also each “Issue” entry is an active link to that particular Issue of the CoC.

1.2.4 Status

[IECEX OD 011-1](#) provides an explanation of the Status options. The “Draft” status should be selected when the ExCB is compiling or preparing the CoC. When saved as a Draft, the CoC remains on the System BUT IT CANNOT be viewed by other ExCBs or the public.

When ready to formally issue the CoC, the issuing ExCB re-enters the IECEx CoC “On-Line” System and then selects the *Draft* CoC. Once the *Draft* CoC appears, the ExCB then selects “Edit” from the options located directly above the CoC. This then opens all fields of the *Draft* CoC ready for any last-minute changes. Once complete and ready to issue, the issuing ExCB

(using a level 2 password access) changes the “Status” field from “Draft” to “Current” and then selects the “Save” option, located directly above the certificate. This step is regarded as the ExCB’s official “Decision to Issue” the certificate, which is similar to the ExCB’s Authorizing Officer signing a paper certificate.

Please note that a *Current* CoC may only be edited by the ExCB in the first 14 days following the date that the Certificate was first set to status of *Current*. Should minor edits of the CoC be required after the 14 day period, the ExCB should contact the Secretariat who can change the status of the CoC back to draft for the minor edits. The ExCB must not change the issue date of the CoC when they save and make the draft CoC Current. If a significant amount of time has lapsed between the issue date and the request to amend the CoC, the Secretariat reserves the right to reject the request to reset the CoC to draft, and the ExCB will be required to up-issue the CoC to implement any changes to the CoC.

Once saved as “Current” the CoC is then available for anyone to view or print.

Once a CoC is issued as *Current*, the issuing ExCB must include the manufacturer under a surveillance program (QAR), in accordance with the [IECEX OD 025](#) and [IECEX OD 009](#). During this surveillance program, an ExCB may identify the need to change the status of an IECEx CoC from *Current* to *Suspended* or even *Cancelled* (refer also to [IECEX OD 209](#)). In this case the ExCB should contact the IECEx Secretariat for assistance as per section 2.2 of this OD.

1.2.5 Date of Issue

The Date of Issue should be regarded as the date on which the ExCB is satisfied that all the requirements of the IECEx System have been satisfied.

1.2.6 Issue No.

The Issue Number acts as a change control device to record the number of changes that have been made to the CoC, with “Issue No. 0” representing the “Original Issue”.

Examples of changes to an IECEx CoC which would require a new version of a CoC cover two broad areas of Administrative and Technical changes. These include:

- Change of Company Name or Certificate Holder;
- Change of product design;
- Change in Manufacturing location;
- Change in ExCB conducting audits and issuing the QAR.

It is imperative that the ExCB understand that the CoCs they issue, are their responsibility. For further details contact the IECEx Secretariat.

Where a manufacturer requests a change to an IECEx CoC, the ExCB must first judge whether such a change is appropriate or whether the change is so great that a new CoC should be issued. An example of this would be the adding of a new series of product models this may be best dealt with by the issuing a new certificate and considered a technical change.

It should be noted that when conducting an audit visit of manufacturers, the one audit visit and hence one IECEx Quality Assessment Report (QAR) might be used to cover more than one IECEx CoC. For example, the one audit visit and one QAR may be used by a manufacturer holding an IECEx CoC for motors and another IECEx CoC for luminaries providing both manufacturing areas are covered during the audit visit.

When an ExCB issues a change to a CoC, the ExCB must include the details of the change in the “Details of Certificate Changes” field. The “Details of Certificate Change” field has been made mandatory and must contain the details before the CoC can be saved.

NOTE: all versions of currently issued IECEx Certificates are all available for public view so there is no need to try to include information about every variation of product or standard on the latest version of a certificate series”

1.2.7 Applicant

The Applicant for a Certificate is the entity defined in IECEx 02, Clause 3.16 and this field of the CoC specifies the name and address of the Applicant.

Note: the Applicant is usually the Manufacturer (refer IECEx 02, Clause 3.17) however another organisation may act as the Applicant on behalf of the Manufacturer.

For equipment produced or sold under license, IECEx 02, Clauses 3.16 and 9.8 apply and IECEx OD 203 details the certification process requirements for a range of cases or scenarios for the involvement of licensees, trade agents and local assemblers.

1.2.8 Equipment (name)

Requires name of equipment and a brief description of the product (that may be an apparatus, fitting, device, component), in terms of its type, function or application and may include details of model or range numbers or names. The equipment name may also assist the public with the search features to identify what they may be looking for, example 'gas detector' model xxx. Details of all models in a range should be included in the "Equipment" field to enable readers to determine if a certificate applies to equipment on-site.

If an Ex Component Certificate has been selected, then this field will be titled as Ex Component.

Optional accessory:

In most cases this may not be required. Again, if there is insufficient space more information may be included in, with a reference to, the Certificate Schedule.

1.2.9 Type of Protection

Relates to the name of the type (or level) of Ex protection, for example, Increased Safety "e"

This should show the type of protection, followed by the symbol for each type of protection including any "a", "b" or "c" suffix designations if applicable. The following are examples of what should be shown in this field:

- for an IECEx CoC involving IEC 60079-1, IEC 60079-7 and IEC 60079-0 for EPL Gb, this field should read - - Flameproof "d" and Increased safety "e"
- for an IECEx CoC involving IEC 60079-11 and IEC 60079-0 for EPL Ga, this field should read - - Intrinsic safety "ia"
- for an IECEx CoC involving IEC 60079-7, IEC 60079-28, IEC 60079-31 and IEC 60079-0 for EPL Gb, this field should read - - Increased safety "e", Inherently safe optical radiation, "op is" and Equipment dust ignition protection by enclosure "t"

Further guidance on Types of Ex protection, their accepted descriptions and identifiers (eg. Flameproof enclosures "d") and the relevant Standards is provided in IEC 60079-0, Clause 1.

1.2.10 Marking

This should show what would be seen on the marking plate concerning the Ex aspect of the product, including the way the Certificate Number should appear.

This should show the Ex marking string as detailed in IEC 60079-0, including the symbol Ex, the symbol for each type of protection used, the symbol of the group, the maximum surface temperature, the equipment protection level and the range of ambient temperature or the symbol "X", where appropriate.

As an example, a product to be marked with "Ex d IIC T4 IP65" must have this 'marking string' defined in the Marking field of the Certificate.

Further guidance on marking requirements and examples of acceptable formats can be found in IEC 60079-0, Clause 29.

1.2.11 Approved for issue on behalf of the IECEx Certification Body

This name should be the person within the ExCB authorized, in accordance with the ExCB's quality system, to issue Certificates. In many cases this person is regarded as the ExCB's "Signatory".

1.2.12 Position

This is the title of the signatory's position within the ExCB.

1.2.13 Signature (printed version only)

This space has been provided for instances where an uncontrolled paper certificate or a copy of a certificate, endorsed by the issuing ExCB may be required. The blank space for signatures only appears when the Certificate is printed as a hard copy.

1.2.14 Date (printed version only)

This space is intended for paper copies of the certificates and is the date when the IECEx Certificate of Conformity is signed.

1.2.15 Manufacturer

This field is for specifying the name and address of the organization that controls and accepts responsibility for continued compliance of the listed Equipment with the relevant requirements of listed Standards and IECEx Rules (refer to IECEx 02, Clause 3.17 for a full definition of Manufacturer) except, in some circumstances, for licensed equipment (See IECEx 02, Clause 9.8 and IECEx OD 203).

A physical (street) address shall be specified and a Postal Box number is not acceptable.

As the specified Manufacturer may control but not carry out the activities of a Manufacturing Location (as defined in IECEx 02, Clause 3.18) the IECEx OCS has, as shown in the examples below, a YES/NO check box option that, when selected as Yes, includes the Manufacturer details in the Manufacturing Locations field of the Certificate so there is a clear link to the QAR Summary content.

Example of when the check box is set to YES:

The screenshot shows the IECEx OCS form on the left and the printed certificate on the right. In the form, the 'MANUFACTURER' field is highlighted with a red box, containing details for 'CZ EXPLOSION-PROOF ELECTRIC APPLIANCES Co., LTD.' and 'HOERBIGER Automatisierungstechnik GmbH'. Below this, the 'ADD THE MANUFACTURER TO THE MANUFACTURING LOCATIONS' section has the 'YES' radio button selected. The printed certificate on the right shows the same manufacturer details included in the 'Manufacturing locations' field of the certificate.

Example of when the check box is set to NO:

The screenshot shows the IECEx OCS form on the left and the printed certificate on the right. In the form, the 'MANUFACTURER' field is highlighted with a red box, containing details for 'CZ EXPLOSION-PROOF ELECTRIC APPLIANCES Co., LTD.' and 'HOERBIGER Automatisierungstechnik GmbH'. Below this, the 'ADD THE MANUFACTURER TO THE MANUFACTURING LOCATIONS' section has the 'NO' radio button selected. The printed certificate on the right shows the manufacturer details not included in the 'Manufacturing locations' field of the certificate.

The Manufacturer shall be specified in the Manufacturer field of the QAR Summary and in the Sites-Locations Audited field of the QAR Summary.

1.2.16 Manufacturing Locations

This field is for specifying the name and address details of all Manufacturing Locations (as defined in IECEx 02, Clause 3.18) where the certified Equipment is produced (up to and including release to market) under the control of the specified Manufacturer (refer Clause 1.2.15 above). When selecting and adding the details of any Manufacturing Locations to a certificate, it may, depending on the age of the certificate, be necessary to “Save” the Draft CoC first then “Edit” to add the details of more Manufacturing Locations. Once the information has been entered it may be deleted/edited as required. When a New Issue of a CoC is raised (See Section 2.2) the data on all existing Locations from the Previous issue is copied into the New Issue so these need to be checked as valid for the New Issue (and removed if not valid). These existing Locations maybe deleted/edited and new Locations added in the New Issue. Previous Issues must not and cannot be changed.

All Manufacturing Locations from where equipment claimed to be covered by an IECEx Certificate is released to market MUST be listed on the Certificate. These Manufacturing Locations shall also be listed in the Sites-Locations Audited of the supporting QAR Summary or QAR Summaries.

It is **not** necessary to specify (on the Certificate or QAR Summary) the details on any Production Sites that are working under the control of a specified Manufacturing Location. To assist in planning an ExCB’s audits of Manufacturing Locations that use, control and audit Production Sites, the QAR Summary issuing ExCB may use the Comment field of the QAR Summary for the Manufacturer or Manufacturing Location to list the details of Production Sites that are audited by staff of the Manufacturer or Manufacturing Location

[IECEX OD 203](#) defines other requirements for Certificate and QAR Summary issue and content where Trade Agents, Distributors or Local Assemblers are involved in the certification process or release of product.

1.2.17 Standards

These are the standards covered by the Certificate of Conformity. The ExCB can only add to the CoC those Standards that are within the approved scope of the ExCB.

1.2.18 IECEx Test & Assessment Report Summaries (Test Report Summary (ExTR) and Quality Assessment Report Summary (QAR))

1.2.18.1 IECEx Test Report (ExTRs) Summary

The reference number of each IECEx Test Report Summary is automatically assigned by the IECEx OCS. Generally, an ExTR will have been issued before it comes time to create a CoC. Therefore the ExCB must use the “Insert/delete ExTR” to insert a link to the appropriate ExTR. The CoC must reflect the Standards and the editions thereof that are listed in the ExTR. [Refer to Section 3 for further guidance and also [IECEX OD 010](#).]

1.2.18.2 IECEx Quality Assessment Report (QAR) Summary

The reference number of each IECEx Quality Assessment Report Summary is automatically assigned by the IECEx OCS. Generally a QAR will have been issued before it comes time to create a CoC. Therefore the ExCB must use the “Insert/delete ExQAR” to insert a link to the appropriate QAR. [Refer to Section 4 for further guidance and also [IECEX OD 009](#)].

When a CoC is up-issued it is good housekeeping to select the latest version of the QAR and remove the old version of the QAR unless there is good reason to use both versions to support the updated CoC. It is also important that should a manufacturing location change, the latest

version/s of the QAR is used and old version/s are removed from the CoC. Essentially, the up-issued CoC should reflect the current status of the QAR or QARs.

1.2.19 Equipment (Field)

This field on the certificate is where detailed information is entered to clearly describe the product(s) covered by the IECEx CoC. A “clear description” of a product (that may be an apparatus, fitting, device or component) should include its type, function or application and may include details of model or range numbers or names. If there is insufficient space for all relevant details eg. for all models in a range, these additional details should be included in an Annex attached to the Certificate and referenced in the Equipment field.

The use of only a brand, range name or a Model or Range designation in this field is not permitted.

As with all other fields, this field accepts basic text being entered directly into the field. A formatting feature is provided to allow special characters to be directly entered into the Certificate – it is suggested that this be used as an alternative to ‘pasting’ formatted text from other documents.

NOTE: In instances where an applicant or ExCB attempts to include large amounts of text or large tables in this field the system will display a “Warning” message but the CoC can still be saved. In such cases it is recommended that the information be included in an attachment to the CoC.

1.2.20 Specific Conditions of Use

Where Specific Conditions of Use are relevant to a particular item of IECEx Certified equipment the Specific Conditions of Use = “YES” option box must be checked. This will automatically assign an “X” after the IECEx CoC number.

Note: The symbol “X” is used to provide a means of identifying that essential information for the installation, use, and maintenance of the equipment is contained within the certificate. (refer Clause 3.53 of IEC 60079-0)

NOTE: If the inclusion of large amounts of text or large tables are included in this field and if the content of this field is very large, a “Warning” message will display but the CoC can still be saved. In such cases it is recommended that the information be included in an attachment to the CoC.

NOTE: IEC TC31 reminds ExCBs that IEC 60079-14 is for installation requirements and does not cover conditions of use for IECEx certificates other than noting they shall be met (in addition to the requirements of IEC 60079-14). To avoid user confusion, IECEx Certificates must not mention a Specific Condition of Use for anything that is covered in IEC 60079-14 because the inclusion of conditions of use which are covered in IEC 60079-14 can create a problem for users where there is any discrepancy in the wording or implied conditions between the certificate and IEC 60079-14. In these cases, users may be unsure as to which document they are required to comply with. For example, since IEC 60079-14 covers the requirements for allowable types of glands with different types of Ex equipment, all certificates should be silent on gland details.

1.2.21 Annex and Attachments

The IECEx “On-Line” Certificate of Conformity System provides a facility for the addition of attachments or annexes to the certificate by selecting the **CHOOSE NEW FILES TO UPLOAD** icon to enable the addition of attachments or annexes to the CoC.

Any annex or attachment to the CoC MUST contain the following information as a minimum:

- The words “Addendum to IECEx Certificate” or “Annex to” on the first page.
- IECEx CoC Reference Number (on all pages)
- Page Number and Total number of Pages (on all pages), e.g. “Page 1 of X”
- Clear details of the information

The required file format for annexes and attachments is **unsecured PDF** as this format enables the option of printing the CoC and associated annexes or attachments to a PDF document.

The annex MUST NOT be used as an alternative to providing a clear description in the Equipment Field. Important equipment information, including equipment description must be included in the CoC. This also enhances the capability of search feature that only interrogate the content of the CoCs (and not the Attachments).

Redline Version

2 Creation of a new IECEx Ex Equipment or Ex Component Certificates of Conformity

2.1 Entering new CoC details

STEP 1: Select “View Certificates & Licenses” from IECEx Website: www.iecex.com or access directly via <https://www.iecex-certs.com>

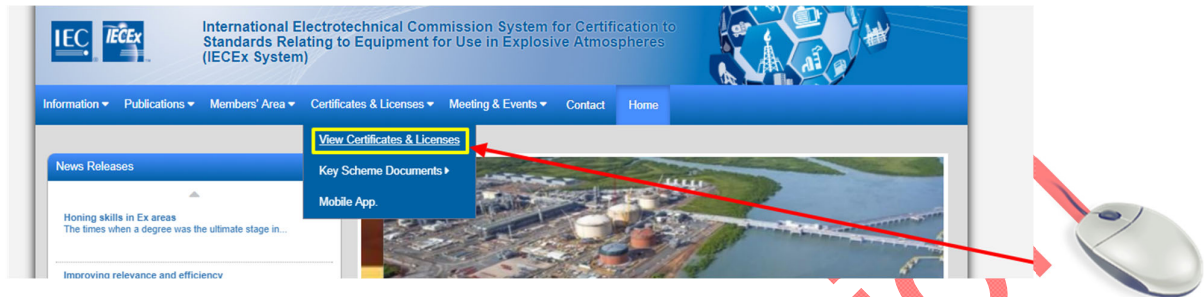

STEP 2: Select ExCB Login and then log on using the assigned user name and password.

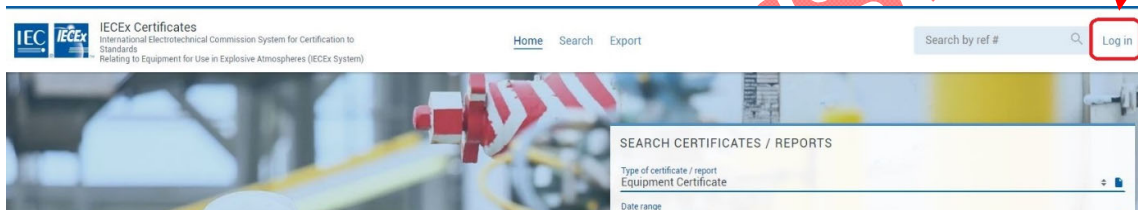

STEP 3: Select “Create”

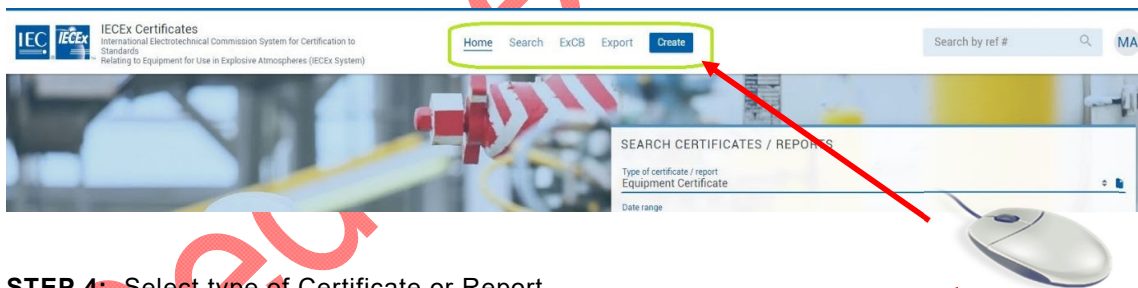

STEP 4: Select type of Certificate or Report

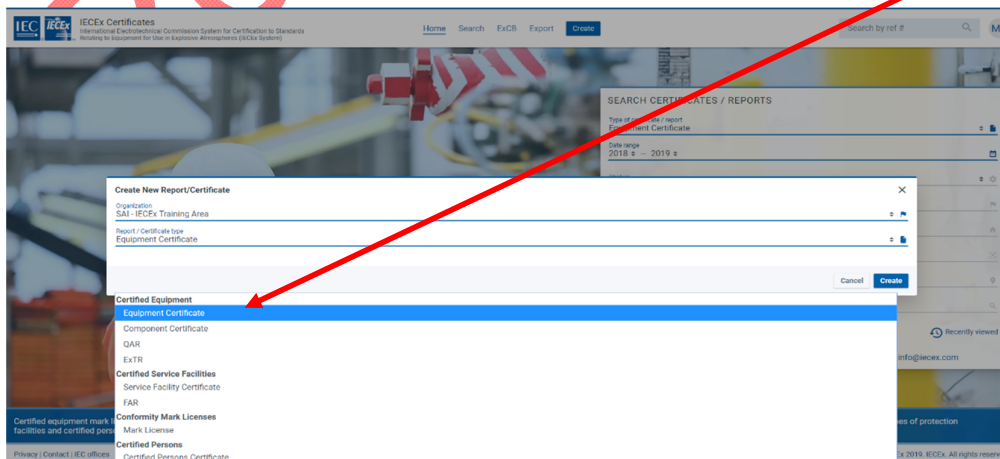

The following screenshots depict how to select either Ex Component OR Ex Equipment certificate type formats at this stage of the certificate creation process:

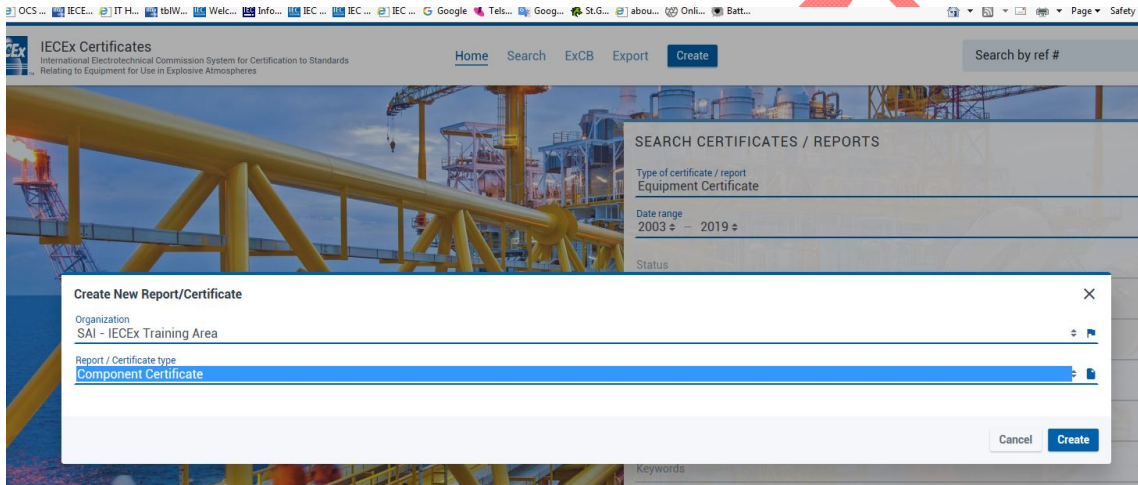
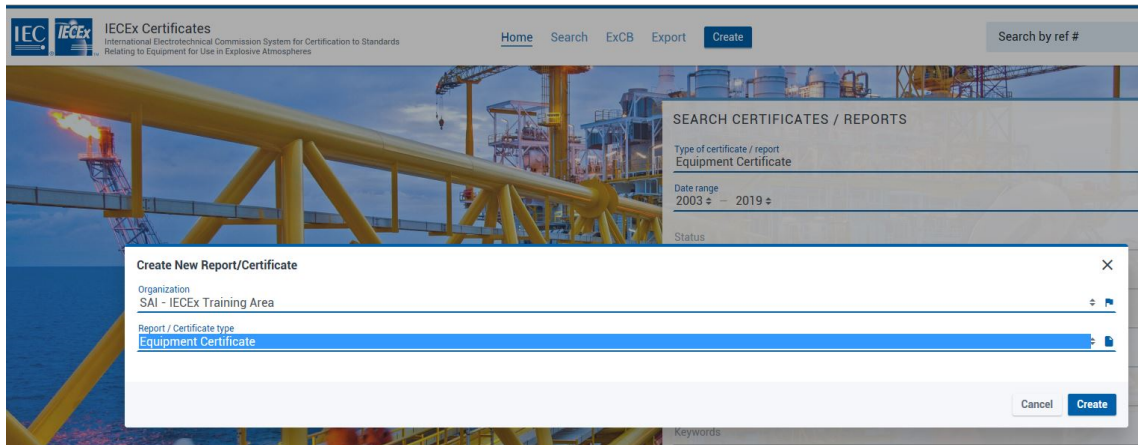

STEP 5: Select the  icon to open edit mode, then add details ([IECEX OD 011-1](#) provides more guidance on data entry processes etc.) and then save as either status = Draft or Current.

Note that some fields (for example, the Applicant field) utilise the ‘auto-suggest’ tool that draws on data already in the IECEx OCS that can be selected so as to avoid the need to type content. The facility also exists to add details to the IECEx OCS database by creating new identities.

You will notice the Status options of “Suspended” and “Cancelled” in addition to “Draft” and “Current” – please contact the IECEx Secretariat for assistance in setting an issued CoC to either “*Suspended*” status (eg. to enable correction or resolution of problems before restoring to “Current”) or “*Cancelled*” status (eg. in the situation where a manufacturer no longer needs the CoC or no longer manufactures the product covered by the CoC) It is important to note that Cancellation is permanent and “Cancelled” CoCs cannot be restored to “Current”. Before contacting the Secretariat for assistance in changing a CoC’s status please advise the CoC’s applicant of intended action and agree on a date of effectivity of the cancellation or suspension – the Secretariat will edit the CoC to include this and a comment on the reason for status change as part of the process status editing. [IECEX OD 209](#) provides more detailed information about the suspension and cancellation of certificates.

ExCBAAdmin level users can directly Edit (there is no need to reset to Draft first) and resave issued Certificates within a period of 14 days after first being set to status = Current to make

editorial corrections (Note that the Save icon only becomes active for use after contents of a field have been changed)

For editorial corrections after the 14 day period, please contact the IECEx Secretariat for assistance.

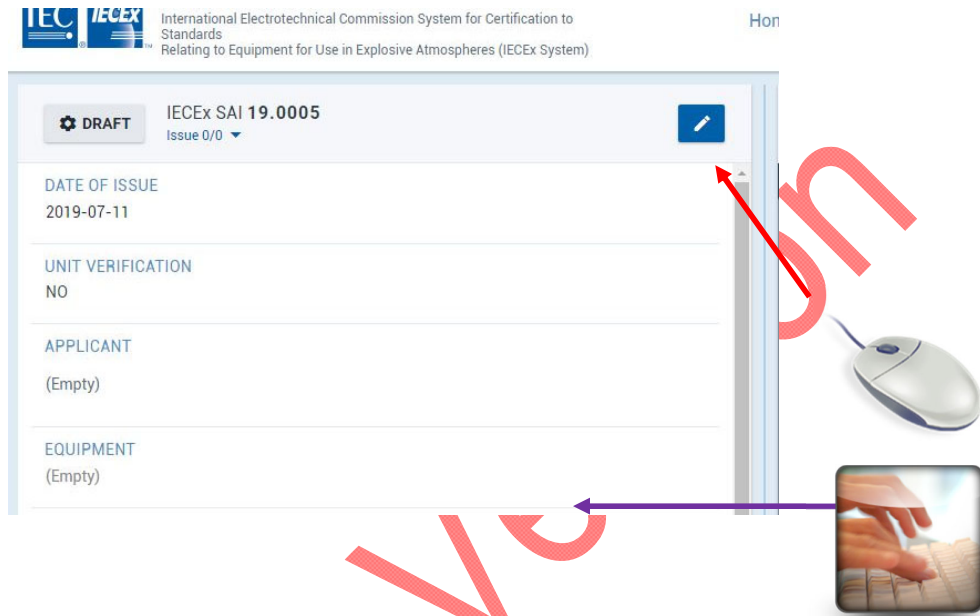

The status of a Certificate or Report can be changed by an **ExCBAdmin** level user by clicking on the status indicator to reveal the Change issue status icon. The status options available to ExCBs are presented in the “Update Status” window when editing a certificate or report – refer example (that shows the full range of options – the actual options vary according to access level rights) below:

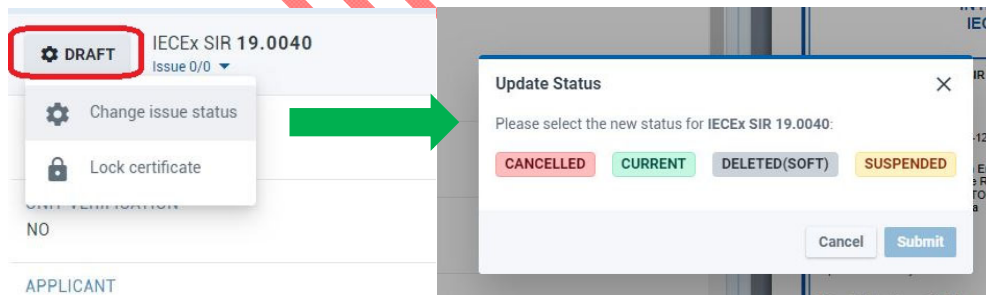

ExCBs do not have access to reset an issued Certificate to status = Draft and it is not necessary to do this if editorial corrections to content are needed within 14 days of first being set to status = Current – in this case the use of the Edit icon is all that is needed.

2.2 Entering ExTR and QAR details

The System provides for the linkage of the Certificate to one or more ExTR Summaries and one or more QAR Summaries that have been previously issued (status = “Issued”) on the IECEx OCS by an issuing ExCB.

When in the “creation” or “edit” mode to create or update an IECEx Certificate, selecting the ExTR field title or the QAR field title opens a window in which the appropriate ExTR Summary or QAR Summary can be searched, highlighted and then selected by use of the  icon to move it to the *Selected* window as shown below. The icon pointing the other way can be used to remove items from the *Selected* window.

NOTE: ExTRs that do not apply to product or variation that is specified on a particular version of a certificate must not be linked to that certificate

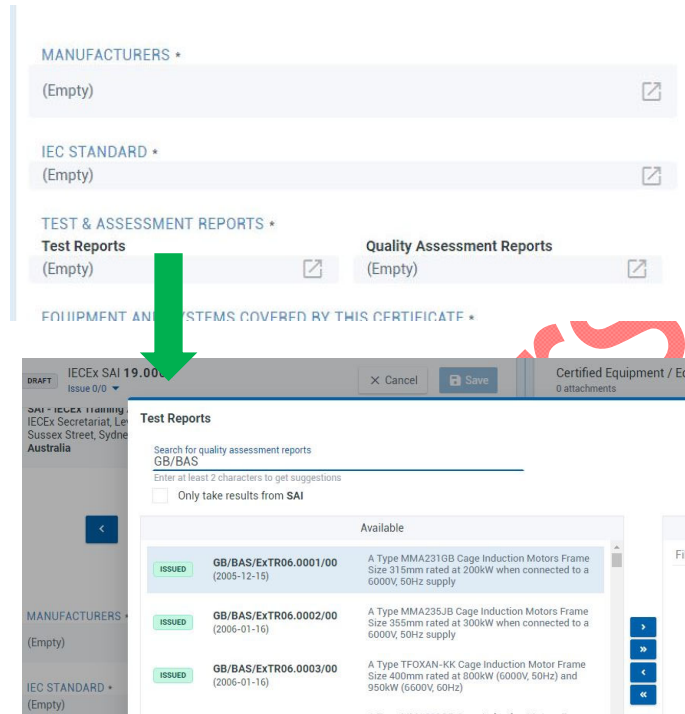

2.3 Formatting Features

When in the edit or creation mode of an IECEx Certificate, there are formatting options to enable ExCBs staff to enter information directly into the Certificate field without the need to create HTML file codes and cut and paste from other software (whilst this is possible, caution needs to be taken so that hidden formatting coding (that can affect the appearance of the PDF file) is not introduced.

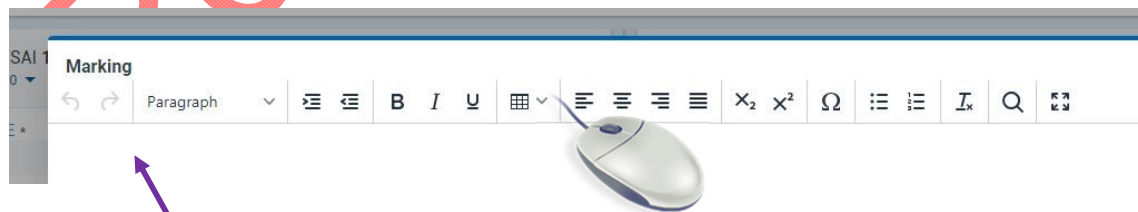

Note: hovering the mouse cursor over an edit bar menu item will display an explanation of the purpose of each icon.



2.4 Creating a “New Issue” of an existing CoC

STEP 1: Open appropriate CoC and select the  icon to open a “New issue”, select “CONFIRM”, fill in details and save (noting that the content of the earlier issue is copied into the new issue and can be retained, edited or removed as required). The “Details of Certificate Changes” field in the new issue will be empty therefore all relevant details of changes for this issue must be added as this field before the new issue can be saved.



Redline

3 Entering Registration of an IECEx ExTR Summary

3.1 Registration of a new IECEx ExTR Summary

STEP 1: Select ExCB Login and then log on using the assigned user name and password.

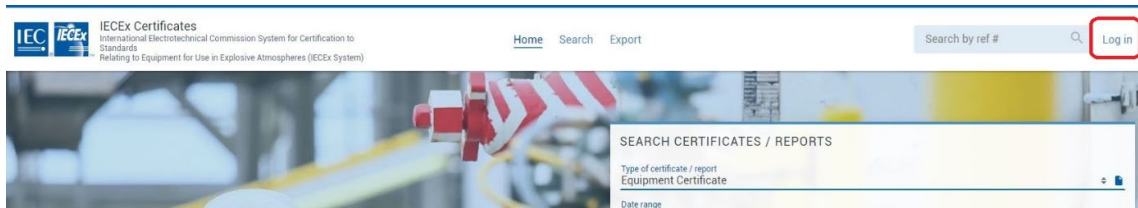

STEP 2: Select “Create”

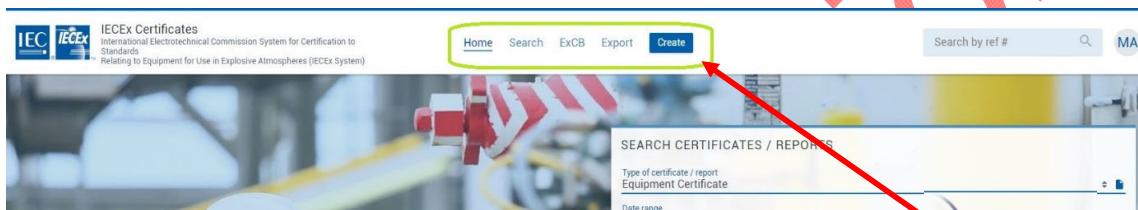

STEP 3: Select type of Certificate or Report as 'ExTR'

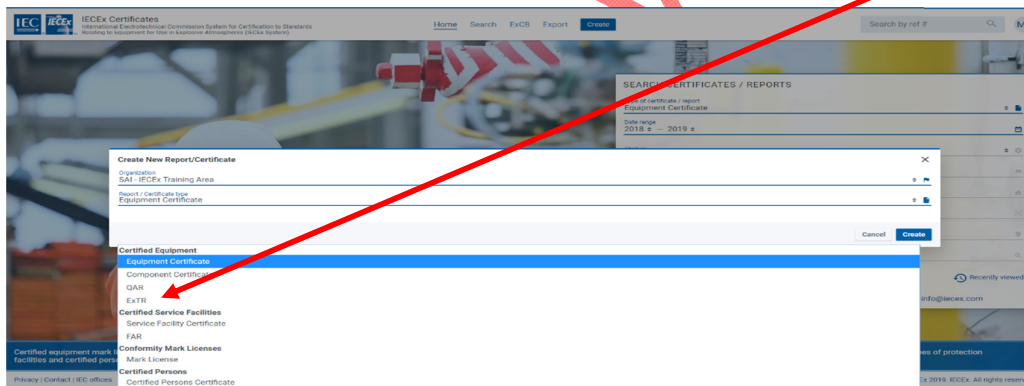

STEP 4: Select the  icon to open edit mode, then add details (IECEx OD 011-1 provides more guidance on data entry processes etc.) and then save as either status = Draft or Issued (noting that only users with *ExCBAdmin* level access rights can set an ExTR Summary to status of Issued). Note that some fields utilise the ‘auto-suggest’ tool that draws on data already in the IECEx OCS that can be selected so as to avoid the need to type content. The facility also exists to add details to the IECEx OCS database by creating new identities.

General Notes:

The IECEx “On-Line” Certificate System allows for the “live” entering of information and details of ExTRs and QARs as well as the IECEx Certificate of Conformity itself. The System recognizes that ExTRs and QARs may be issued independently as well as in conjunction with the issuing of an IECEx Certificate of Conformity. Furthermore, the System is structured on a “linkage” system whereby an IECEx certificate of Conformity may be linked to one or more ExTRs and QARs. For example, where a product that is to be covered by an IECEx Certificate of Conformity is manufactured at two or more locations, then there may be two or more QARs issued one being for each manufacturing location, especially if manufactured in more than 1 country.

3.2 Notes for the various fields of an ExTR Summary:

ExTR Number This number is generated by the System with the following assigned attributes – an example of an ExTR endorsed in Norway (NO) by the ExCB “Presafe” follows:-

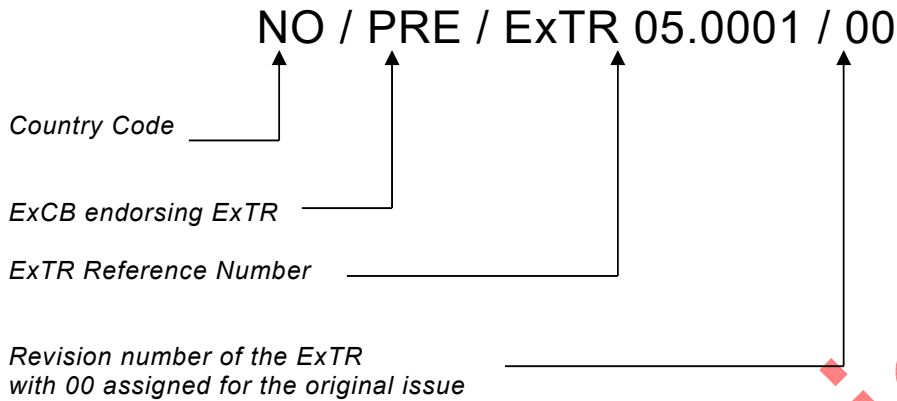

Note: The System allows for additional reference numbers to be added, for internal ExCB use, but the System only lists according to the number generated by the System. In addition, there is a comments field where additional information may also be included, such as ExCB file numbers etc.

Status

This feature allows the ExTR to be saved as either a “Draft” or as “Issued”. Note that the ExTR must be saved as status = “Issued” before the linked Certificate can be saved as status = “Current”.

ExCBAdmin level users can directly Edit (there is no need to reset to Draft first) and resave issued ExTR Summaries at any time after first being set to status = *Issued* to make editorial corrections (Note that the Save icon only becomes active for use after contents of a field have been changed). Any changes to the technical content of the ExTR Summary must be done by creating a new version of the ExTR Summary.

ExTR Free Reference Number:

This field enables an ExCB to include any internal reference number to assist in internal traceability purposes. Note that the IECEx “On-Line” System uses the automatically generated Number and therefore the preferred situation is for the ExTL and ExCB to adopt the ExTR numbering system that is automatically generated by the System. In any case, the System will not allow a deletion or change to the automated Number that has been assigned by the System.

Date of Issue:

(Mandatory Field – this field must include content for the ExTR to set to status = “Issued”):
The date of issue of the ExTR is to be specified here. The system will default by showing the current day that the “New ExTR” window was opened.

Details of Change:

The details of change should be completed when a new version of an existing ExTR is issued.

List of Standards:

(Mandatory Field):
As selected from the drop down list

Issuing ExTL

(Mandatory Field):
As selected from the drop down list, with the default being the body that opened the ExTR details window.

Endorsing ExCB

(Mandatory Field)

As selected from the drop down list, with the default being the body that opened the ExTR details window.

Manufacturer

(Mandatory Field)

(refer to [IECEX 02, clause 3.17](#))

Ex Protection

(Mandatory Field)

An example of such information is *Ex d e IIC T3 or Ex d I*

Ratings

This is generally any electrical or other operational ratings that may apply.

Model Reference

(Mandatory Field)

Related IECEx Certificate

(Automatic field)

The related CoC number is automatically inserted when the ExTR is linked to a CoC

Comments

(Optional Field)

This area is completely free for the ExCB to record any relevant information that may assist the International Ex industry understand the product and or the ExTR.

Attachments

This field enables the optional attachment of additional information or documents if necessary.

3.3 Supplementary or changes to an issued ExTR Summary

Application: This Clause applies where it is necessary to issue a supplement to an issued ExTR, for example to correct an error that was contained in the original ExTR.

STEP 1: Open appropriate ExTR Summary select the  icon to open a “New issue”, select “CONFIRM” and fill in details (noting that the content of the earlier issue is copied into the new issue and can be retained, edited or removed as required). The “Comments” field may be used to outline the details of changes as compared to the earlier version.

Step 2: When completed, select “Save” from the top bar of the edit screen to save the ExTR Summary as status of Draft or Issued (noting that only users with *ExCBAdmin* level access rights can set an ExTR Summary to status of Issued)

4 Registration of an IECEx QAR Summary

4.1 Registration of a new IECEx QAR Summary

STEP 1: Select ExCB Login and then log on using the assigned user name and password.

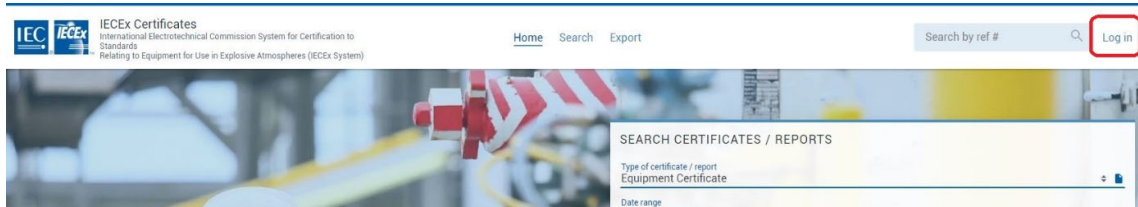

STEP 2: Select “Create”

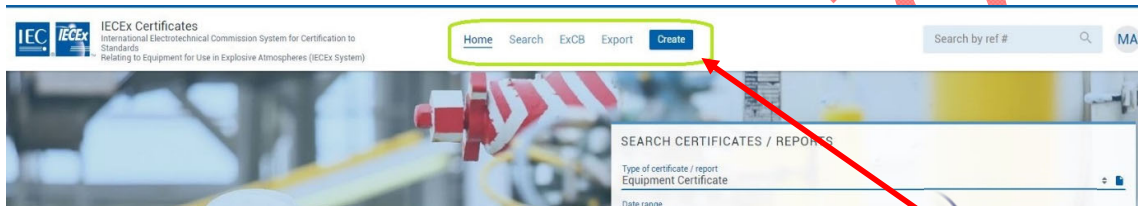

STEP 3: Select type of Certificate or Report as 'QAR'

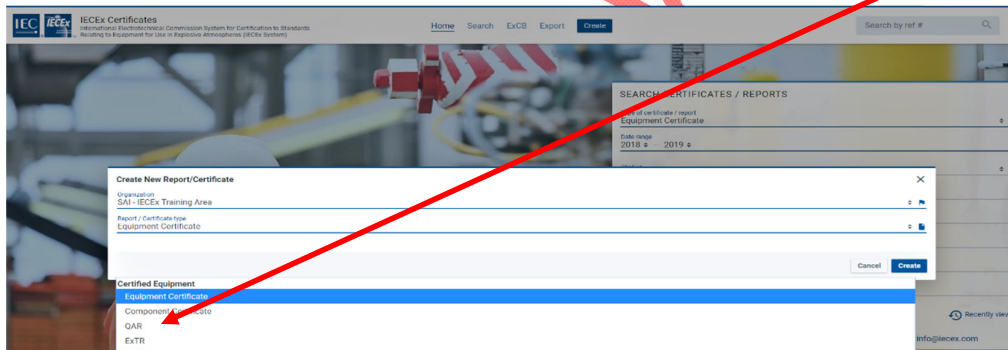

STEP 4: Select the  icon to open edit mode, then add details (IECEx OD 011-1 provides more guidance on data entry processes etc.) and then save as either status = Draft or Issued (noting that only users with *ExCBAdmin* level access rights can set a QAR Summary to status of Issued).

Note that some fields utilise the ‘auto-suggest’ tool that draws on data already in the IECEx OCS that can be selected so as to avoid the need to type content. The facility also exists to add details to the IECEx OCS database by creating new identities.

General Notes:

The IECEx “On-Line” Certificate System allows for the “live” entering of information and details of ExTRs and QARs as well as the IECEx Certificate of Conformity itself. The System recognizes that ExTRs and QARs may be issued independently as well as in conjunction with the issuing of an IECEx Certificate of Conformity. Furthermore, the System is structured on a “linkage” system whereby an IECEx Certificate of Conformity may be linked to one or more ExTRs and QARs. For example, where a product that is to be covered by an IECEx Certificate of Conformity is manufactured at two or more locations, then there may be two or more QARs issued one being for each manufacturing location, especially if manufactured in more than one country.

4.2 Notes for the various Fields of an IECEx QAR Summary (“QAR”):

QAR Number This number is generated by the System with the following assigned attributes- an example of an QAR issued in Great Britain (GB) by the ExCB ‘SGS Baseefa’ follows:

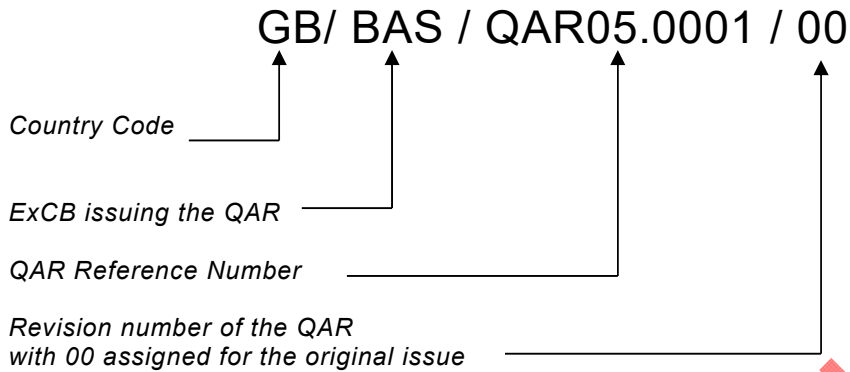

Note 1: versions of a QAR Summary (eg. /00, /01, / 02 etcetra form the parts of a “QAR Summary series”

Note 2: The System allows for additional reference numbers to be added for internal ExCB use, but the System only lists according to the number generated by the System. In addition, there is a comments field where additional information may also be included, such as ExCB file numbers etc.

Status

This feature allows the QAR to be saved as either a “Draft” or as “Issued”. Note that the QAR must be saved as status = “Issued” before it can be linked to a CoC.

ExCBAdmin level users can directly Edit (there is no need to reset to Draft first) and resave issued QAR Summaries at any time after first being set to status = *Issued* to make editorial corrections (Note that the Save icon only becomes active for use after contents of a field have been changed). Any changes to the technical content of the QAR Summary must be done by creating a new version of the QAR Summary.

QAR Free Reference Number

This field enables an ExCB to add numbers/letters or other characters to the QAR Reference Number generated by the “On-Line” CoC System.

The preferred situation is for the ExCB to adopt the QAR numbering system that is automatically generated by the System.

In any case, the system will not allow a deletion or change to the automated Number that has been assigned by the System.

Audit Date:

The date that the audit was conducted, or the date of the last day for multi-day audits, shall be specified here. ~~This is the date that ALL activities have been completed according to the process defined in Section 6 of IECEx OD 025 and that ALL critical elements of the audit programme have been completed (as per Clause 6.7 of IECEx OD 025) as follows:~~

- ~~a) the Audit Conclusion (refer Clause 3.6 of IECEx OD 025) has been provided to, and discussed with the auditee in the form of an audit report (refer to Clauses 6.6.1 and 6.6.2 of IECEx OD 025), and~~
- ~~b) that all major and minor NCRs have been acknowledged by the auditee, and~~
- ~~c) the audit result is rated as only either A, B, C or D according Clause 6.8.1 of IECEx OD 025 AND the appropriate action has been taken or is planned on linked certificates according to the requirements for the applied rating, and~~
- ~~d) that the auditee has an acceptable plan and timetable for corrective and recurrence prevention action of all major and minor non-conformances~~

~~In future and subsequent updates or “new versions” of the QAR Summary series this date will need to be updated to reflect the date of subsequent Surveillance or Re-assessment audits. In the interests of good service to manufacturer clients, this date should not normally be more~~

~~than 90 calendar days after the closing meeting (refer Section 6.5.7 of IECEx OD 025) of the associated audit(s).~~

Date of Issue:

The date of issue of the particular version of the QAR Summary is to be specified here. This date is the day that the relevant ExCB endorsed the QAR Summary and registered it on the IECEx On-line System by setting it to status = Issued in accordance with [Clause 6.8.2 of IECEx OD 025](#).

When endorsing the QAR, ALL activities are to have been completed according to the process defined in Section 6 of IECEx OD 025 and that ALL critical elements of the audit programme have been completed (as per Clause 6.7 of IECEx OD 025) as follows:

a) the Audit Conclusion (refer Clause 3.6 of IECEx OD 025) has been provided to, and discussed with the auditee in the form of an audit report (refer to Clauses 6.6.1 and 6.6.2 of IECEx OD 025), and
b) that all major and minor NCRs have been acknowledged by the auditee, and
c) the audit result is rated as only either A, B, C or D according Clause 6.8.1 of IECEx OD 025 AND the appropriate action has been taken or is planned on linked certificates according to the requirements for the applied rating, and d) that the auditee has an acceptable plan and timetable for corrective and recurrence prevention action of all major and minor non-conformances In the interests of good service to manufacturer clients, this date should not normally be more than 90 calendar days after the closing meeting (refer Section 6.5.7 of IECEx OD 025) of the associated audit(s).

~~This date will usually be the same as the Audit Date as defined above however this can be edited if necessary.~~

Guidance on audit follow up actions that precede the issue of a QAR Summary for different types of assessments is provided in [Clause 6.8.1 of IECEx OD 025](#).

Note: This field was originally titled "Date of original issue" but was changed to "Date of Issue" following ExMC acceptance of a recommendation by ExMC WG5 in June 2013. ~~Note that QARs registered under the original approach will not automatically show the correct Date of Issue as explained above.~~

Valid until:

This date is the expiry date of the QAR Summary after which the linked Certificates cannot be considered as valid and nor can product marked with the Certificate ID # be considered as IECEx Certified until the QAR Summary series is updated to show a later *Valid Until:* date. This is NOT the due date of the next audit and reassessment audits must be scheduled to occur before this date so that the auditee has time to address any major non-conformances and therefore allow the QAR Summary to be updated and issued before the *Valid Until:* date.

According to [Clause 8.3.2 of IECEx 02](#), a QAR has a limited duration of three years – therefore the validity date of a QAR Summary shall ~~should be~~ not be more than three years after the initial Audit Date (as defined above) for the initial assessment and can be extended for a further three years from that date after each successful ~~or the most recent~~ re-assessment audit of the manufacturer and manufacturing ~~sites~~ locations listed on the QAR Summary (refer [IECEx OD 025, Clauses 3.16, 3.17 and 3.18](#) regarding the different types of assessment). It is not intended that this field be used to advise the date of the next surveillance audit.

Note: For example, if the initial audit date is 2020-06-01, then the validity date would be 2023-06-01. After the reassessment in 2023, the next validity date would be 2026-06-01 and so on. If a certificate is suspended, the new validity date shall be three years from the audit date to remove the suspension. If an audit is not conducted to remove the suspension, the validity date shall not be altered

In line with the above and to assist ExCBs, a new or draft of an updated QAR Summary will appear with the date fields automatically inserted (on the basis of the date of editing and the above requirements for setting these dates) however all of these can be changed by the issuing ExCB to reflect the actual dates of each event or deadline (and warning messages may be displayed if unexpected, unusual or invalid dates are used when editing the automatically inserted date)

It is at the discretion of the ExCB the *Valid Until*: date can be specified to be less than 3 years after the Audit Date. For example, the ExCB may purposely reduce the period until the next re-assessment date due to findings from the most recent surveillance or assessment audit.

The *Valid Until*: date shall continue to fall on or before the next three year anniversary of the initial audit date.

~~Normally the *Valid Until*: date shall not be more than 3 years after the Audit Date (as defined above) however, u~~Under exceptional circumstances, the ExCB may need to extend the *Valid Until*: date for a specific QAR Summary version by a period of not more than 3 months. In this situation the duration of this extension should be minimised and the ExCB must document the reasons for providing this extension and also document the basis for determining the extension period.

If a QAR Summary is being up-issued to reflect that a surveillance audit (and not a reassessment audit) has been done the system (not being aware of why the QAR Summary is being up-issued) will change the *Valid Until*: date to be three years after the Audit Date field content. As it is not permitted to extend the *Valid Until*: date as a result of a surveillance audit it is recommended that in the situation of a QAR Summary for a surveillance audit the following process is used:

1. Open the QAR Summary to be up-issued
2. Take note of the *Valid Until*: date
3. Select the Edit icon
4. Enter new Audit Date details
5. Reset the *Valid Until* date to the date noted in Step 2 above
6. Save the up-issued QAR Summary

At the request of the manufacturer a reassessment may be conducted earlier than the *Valid Until*: date. In this case the 3 year period is reset.

~~Sites~~ Locations audited:

This is where the Manufacturer and Manufacturing Location(s) must be clearly shown by using a street address – a Postal Box address for the manufacturer is not acceptable.

Issuing ExCB

This is the ExCB that has prepared and issued the QAR Summary.

Manufacturer

The name and contact address for the manufacturer must be recorded here. In most cases the site audited may also be the same address for the manufacturer in which case this would be repeated. (refer to [IECEX 02, clause 3.17](#))

Manufacturing Location

Refer to definitions [3.17](#), [3.18](#) and [3.19](#) in [IECEX 02](#) regarding locations ~~and sites~~ that must be considered as manufacturing locations. The location(s) of manufacture shown on the QAR Summary must match the full list of Manufacturing Location(s) shown on the linked Certificate(s).

Product information

Some information about the type of products covered to be recorded here.

Protection concepts

Information about the protection techniques covered is to be recorded here.

Related QARs

The “Related QARs” field is visible when a new version of a QAR is saved. This field shows all the previous versions of the QAR. These are “live” links” and each QAR can be opened to view history.

Related IECEx Certificate

(Automatic field)

As it is possible that a QAR can be issued without issuing an IECEx CoC, this field may be empty. However, it should be noted that the related CoC number is automatically inserted when the QAR is linked to a CoC at draft or issued status.

Related Certificates

(manual insertion)

This field is only to be used for CoCs that were issued prior to 2007, when the automatic linking feature was not yet available. This feature is being maintained only for old CoCs (pre 2007) that are still current and may be required to be up-issued, using this manual insertion feature.

Related IECEx Certificates for Previous Versions

The “Related IECEx Certificates for all previous versions” field is also visible and shows all CoCs that were automatically linked to previous versions of the QAR Summary series. This means that the latest version of a QAR will not only list the CoCs linked to that version but will contain a list of all CoCs linked to all previous versions in the same QAR Summary series.

Redline Version

Comments

(Optional Field)

This area is completely free for the ExCB to record any relevant information that may assist the International Ex industry understand the product and /or the QAR. This field is useful to track the history of a QAR, or to include such messages as, Manufacturer name change, or change of address or QAR will be discontinued and taken over by QARxxx

In the situation where an Applicant or Manufacturer advises the relevant ExCB that they wish to cease audits against a specific QAR Summary, the QAR Summary's issuing ExCB can use of the stopwatch icon (see screenshot below)

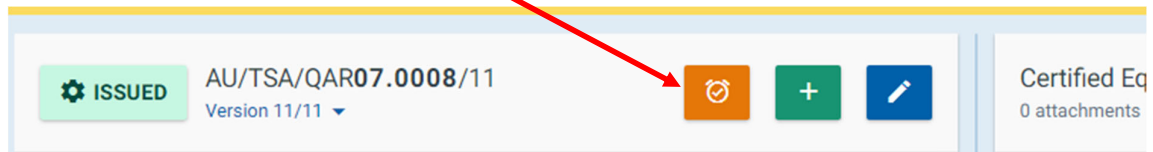

to set the date after which the QAR series will not be maintained or updated, messages regarding this will appear in the top of the online QAR Summary view and also in the Comment field as shown below:

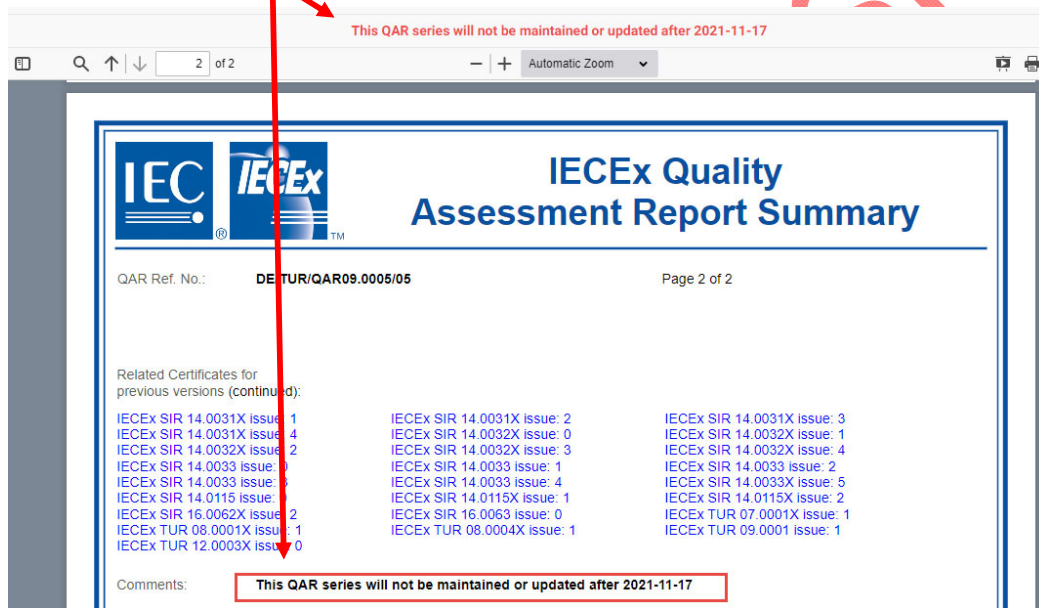

Following the above step, the IECEx OCS will automatically send an email notification of the changes to previously nominated contact persons at all ExCBs that are affected (for example, have issued certificates linked to the QAR series). The list of nominated ExCB contact persons is maintained in the IECEx OCS Backoffice ExCB profile by the IECEx Secretariat and all requests for changes or additions to the list of contacts for each ExCB should be directed to the Secretariat. An example of the content of the automated email notification is shown below:

Please note that the IECEx Series FI/VTT/QAR17.0001/00 will not be maintained or updated after 2021-11-22 and as your organization has issued Certificates that are linked to this QAR series you now need to either up-issue the Certificate(s) with a link to a replacement QAR series OR the Certificate(s) need to be either temporarily suspended or permanently cancelled. Refer IECEx OD 250 and IECEx OD 209 for process guidance

Attachments

This field enables the optional attachment of additional information or documents if necessary.

4.3 Supplementary or changes/updates to an Issued QAR Summary

4.3.1 Application:

This Clause applies where it is necessary to issue a supplement (New version) to an issued QAR Summary as an update on the QAR Summary series. In most cases the cause for the update will be to inform that a surveillance audit has been completed before the “Valid until” date has been reached [refer [IECEX OD 009, Step 13](#) for guidance].

Note: When the QAR is updated, normally there is no need to update the CoC as it is automatically linked to a previous issue of the QAR. Also any issue of a QAR is automatically linked to all other issues of the QAR. It is good housekeeping that when a CoC is up-issued, the QAR is updated to the latest issue and the QARs are reviewed ensuring only those that are relevant to the CoC are included.

If a QAR Summary is being up-issued to reflect that a surveillance audit (and not a reassessment audit) has been done the system (not being aware of why the QAR Summary is being up-issued) will change the Valid Until: date to be three years after the Audit Date field content. As it is not permitted to extend the Valid Until: date as a result of a surveillance audit it is recommended that in the situation of a QAR Summary for a surveillance audit the following process is used:

1. Open the QAR Summary to be up-issued
2. Take note of the Valid Until: date
3. Select the Edit icon
4. Enter new Audit Date details
5. Reset the Valid Until date to the date noted in Step 2 above
6. Save the up-issued QAR Summary

It is preferred that QAR Summary series are updated (by preparing a New Version) as opposed to the creation of a New QAR Summary (ie. a new series with a different QAR number) following a surveillance audit so that the links to associated CoCs are maintained.

Where a New QAR Summary is issued by an ExCB to

- reflect that they have taken over the surveillance of the manufacturer [refer to [IECEX OD 250](#) for typical scenarios], or
- supersede the original QAR, the ExCB must use the Comment field to (i) reference the Original QAR in the New QAR and (ii) explain the reason for issue of the New QAR. This action will enable the IEC Secretariat to remove the superseded QAR from the ExCB(s) lists of “Out-of-Date QARs” and “CoCs with Out-of-Date QARs” [refer to [IECEX OD 250](#) for more information on this process].

It is recommended that the “*Comment*” field of the new QAR Version be used to indicate the reason for the issue of this version of the QAR, ie. whether it was for an initial assessment, a surveillance assessment or a re-assessment conducted at or before the three year expiry date of the QAR [refer [IECEX OD 025, Clauses 3.16, 3.17 and 3.18](#) regarding the different types of assessment] – this will assist in determining the validity date of the QAR when planning the next audit [refer [IECEX OD 025, Clause 5.2.2.2.2](#) for guidance in determining the frequency of surveillance assessments].

STEP 1: Open appropriate QAR Summary select the  icon to open a “New issue”, select “CONFIRM” and fill in details (noting that the content of the earlier issue is copied into the new issue and can be retained, edited or removed as required). The “Comments” field may be used to outline the details of changes as compared to the earlier version.

Step 2: When completed, select “Save” from the top bar of the edit screen to save the QAR Summary as status of Draft or Issued (noting that only users with ExCBAdmin level access rights can set a QAR Summary to status of Issued)

4.4 Management of the validity of QAR Summaries and linked Certificates

The IECEx OCS 'Back Office' (refer to [IECEX OD 011-1](#) and [IECEX OD 011-10](#) for more details) includes reports on the validity status of QAR Summaries and also the details of Certificates that are linked to QAR Summaries where the 'Valid until date' has passed.

[IECEX OD 250](#) provides guidance on the necessary actions to be taken under various scenarios for 'out of date QARs'.

These reports available in the 'Back Office' (and sorting within columns and advanced filtering tools for the reports) are available under the 'Reports / Reports – Out of Date' section as shown below:

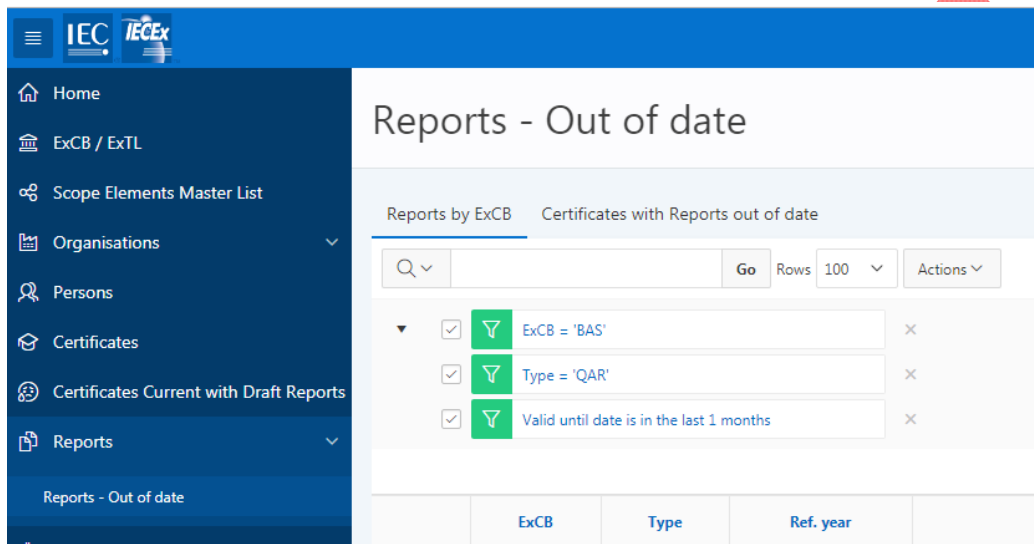

5 Creation of a UNIT VERIFICATION type of IECEx Equipment Certificate of Conformity

5.1 Entering new Unit Verification CoC details

Unit Verification is used to issue IECEx Certificates that cover a defined number of products/items that are produced under a single production run. Unit Verification CoCs must list the serial numbers or other unique identification to be clear which specific items are covered by Certification. No QAR is required or verified at the time of issuing an IECEx Unit Verification Certificate. (refer to [IECEx OD 033](#) for further information in regards to Unit Verification)

STEP 1: Select “View Certificates & Licenses” from IECEx Website: www.iecex.com or access directly via <https://www.iecex-certs.com>

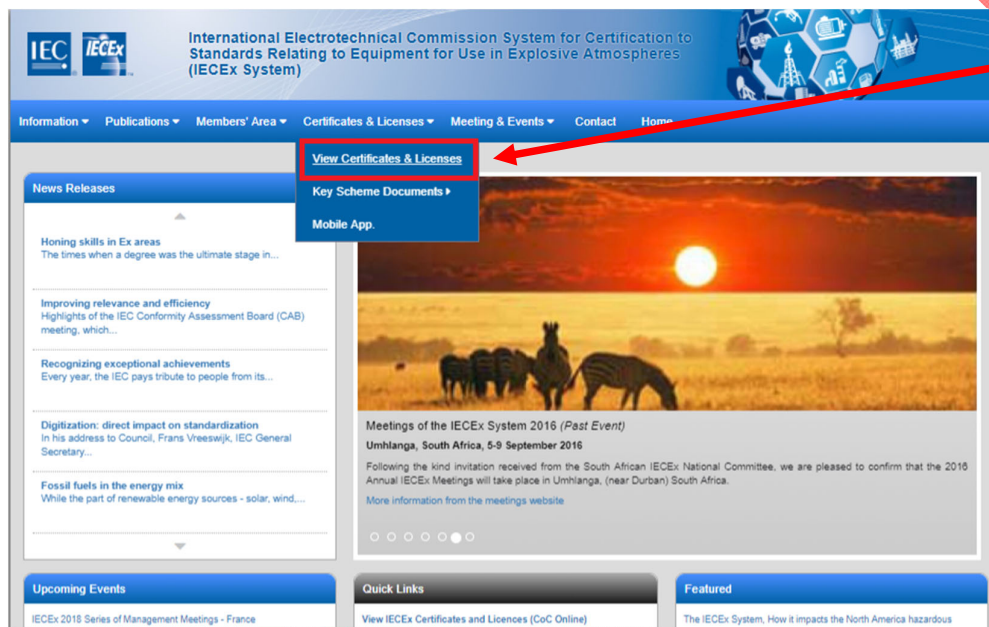

STEP 2: Select ExCB Login and then log on using the assigned user name and password.

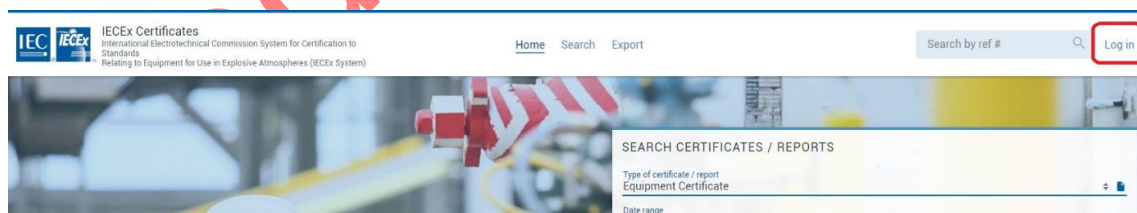

STEP 3: Select “Create”

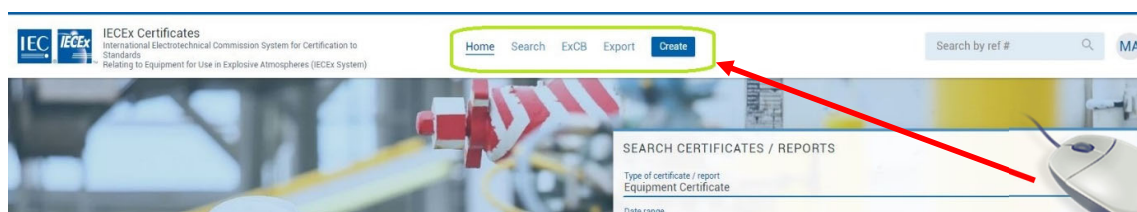

STEP 4: Select type of Certificate or Report as either Equipment Certificate OR Component Certificate type (either type can be a Unit Verification Certificate) as appropriate.

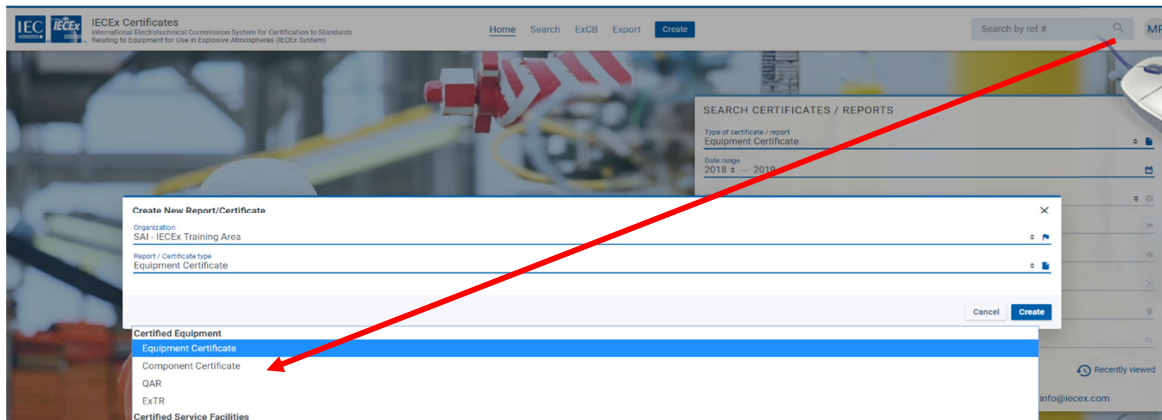

STEP 5: Select the  icon to open edit mode, then add details (IECEX OD 011-1 provides more guidance on data entry processes etc.) and then save as either status = Draft or Current (noting that only users with *ExCBAAdmin* level access rights can set a CoC to status of Current).

Note that some fields utilise the 'auto-suggest' tool that draws on data already in the IECEx OCS that can be selected so as to avoid the need to type content. The facility also exists to add details to the IECEx OCS database by creating new identities.

IMPORTANT NOTE: if a certificate is to be issued as Unit Verification type certificate for an Ex Component (Certificate # will appear with "U" suffix and have a field for Serial Number) or to include Specific Conditions of Use (Certificate # will appear with "X" suffix and have a field for Serial Number) please DO NOT link a QAR to the Draft Certificate. If a QAR has been linked in earlier draft preparation it must be removed before the option of Unit Verification = YES is selected as explained in the next step.

STEP 6: Select UNIT VERIFICATION = YES option as shown in the following example. This action will also modify the title of the Certificate to include 'UNIT VERIFICATION' (unless it has been previously selected as an Ex Component type certificate in which case the title will be "Ex COMPONENT CERTIFICATE") and add a statement that explains why the Certificate is not linked to a QAR Summary.

STEP 7: Insert relevant details (except a link to a QAR as explained in the Important Note above) as if preparing a normal Equipment or Component Certificate AND also insert the Serial Number(s) or other form of unique identification for each unit of equipment to be covered by the Certificate

The screenshot shows a web form for IECEx SAI 19.0006. At the top left, it says 'DRAFT' and 'Issue 0/0'. At the top right, there are 'Cancel' and 'Save' buttons. The form contains several fields: 'DATE OF ISSUE *' with the value '2019-07-12'; 'UNIT VERIFICATION' with radio buttons for 'YES' (selected) and 'NO'; 'APPLICANT *' with '(Empty)'; 'EQUIPMENT *' with '(Empty)'; and 'SERIAL NUMBER *' with '(Empty)'. A red box highlights the 'UNIT VERIFICATION' section, and a blue box highlights the 'SERIAL NUMBER *' field.

Note that it is not permitted to change an already issued Equipment or Component Certificate to Unit Verification type.

It is also not permitted to 'up-issue' a Unit Verification Certificate (for example to add extra units of equipment). As IECEx Unit Verification certificates cover specific items, any changes to products covered by an IECEx Unit Verification Certificate, that are not already provided for by the certificate, shall require the issuing of a new Unit Verification Certificate, as per IECEx OD 033.

If there is a need to create a New version of a Unit Verification Certificate to correct editorial errors, a request to the IECEx Secretariat will be required.

Reading Order

ANNEX A

Informative

Review of Certificates of Conformity Quality Check and the Top Six Identified Items for Improvement

The Secretariat conducts regular reviews of the online IECEx Equipment Certificates of Conformity, targeting a sample rate of 15% of issued Certificates. Overall, the results of this ongoing review illustrate that ExCBs are doing an excellent job. However, the reviews have identified items for improvement. The items for improvement are listed here to assist ExCBs for internal training purposes and as a continuous improvement tool, ensuring that all Certificates that are created are accurate and in accordance with this document, IECEx OD 011-2

1. Equipment Name and Equipment Description is NOT clear and sufficiently detailed. The information within these fields should provide the necessary information for the end user and provide key information so that the IECEx Search Tools assists end users to browse CoC products efficiently.
2. Manufacturer on CoC does NOT match QAR details and/or QAR(s) does NOT cover all manufacturing locations listed on the CoC. Refer to sections 1.2.16 and 1.2.17 of this OD for further information.
3. Linked QAR is NOT current
To best manage QARs and their validity, ExCBs must manage the audit process so that QARs do not lapse. If a QAR lapses, then the CoC must be suspended, or cancelled depending on the situation. Refer to OD 250 for further information.

ExCBs not tracking CoCs linked to other ExCBs QARs. It is the responsibility of the issuing ExCB of the CoC to ensure that the CoC is always linked to a current QAR, whether the QAR is their own or generated by another ExCB.
(Refer to [OD 250](#) for further information on the management of QARs)

4. Standards listed on the CoC do NOT match Standards (including Edition #) on the ExTR (main issue observed was CoC citing later Edition than ExTR).
When inserting multiple Standards from the menu list, the Ctrl button must be held down so caution should be used as well as a review when selecting Standards.
5. Certificates of Conformity have the feature of PDF downloading of CoCs as documents. This feature, although very useful, may create erroneous character or text as a result of 'copy and paste' due to compatibility issues between HTML and XML. Refer to section 1.1.4 of this OD for further information.
6. Draft CoCs are created, but are later determined to be not required, so the ExCB clicks on the Cancelled (status) option in the edit view of the draft CoC. The Cancelled status should not be used to Cancel an unwanted draft or a draft that was created by mistake. The Cancelled option must only be used by the Secretariat, as per [OD 209](#).

Draft certificates should be reviewed by ExCBs and when they are determined to be of no use (will not be made Current) should be deleted by the ExCB. Once deleted, they will no longer be accessible by the ExCB or the Secretariat.